

Synex™ System

TECHNIQUE GUIDE

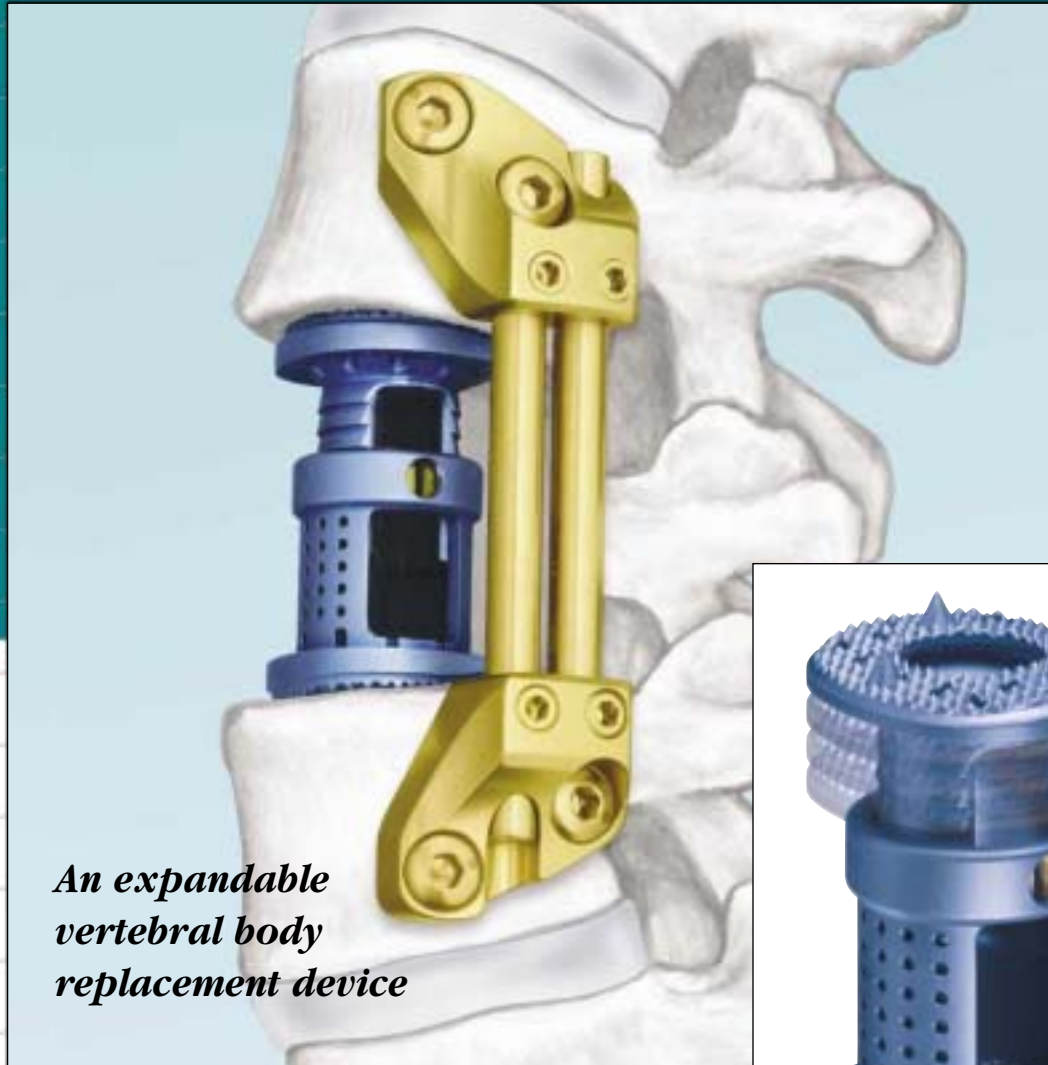

Synex™ System Overview

The Synex™ implant is an expandable vertebral body replacement device that is available in several heights and various endplate configurations. The self-locking implant provides an efficient means of restoring proper spinal alignment using rapid and controlled in situ expansion with minimal instrumentation. The convex endplates are anatomically designed to minimize subsidence while optimizing bone graft placement following expansion.

System features

- Self-locking ratchet expansion mechanism
- Rapid and controlled in situ expansion
- Large endplate contact surfaces
- Minimal instrumentation
- Implants made from titanium alloy (Ti-6Al-7Nb)

Indications

The Synex implant is a vertebral body replacement device intended for use in the thoracolumbar spine (T1–L5) to replace a collapsed, damaged, or unstable vertebral body resulting from tumor or traumatic fracture. The Synex implant can be packed with bone and should be used with Synthes supplemental internal fixation systems, such as ATLP, VestroFix and USS.

Synex implants are designed to provide anterior spinal column support even in the absence of fusion for a prolonged period.



Table of Contents

Introduction

AO Principles of the Synex System	2
---	---

Product Information

Implant Features	4
Implant Configurations	5
Synex Instruments	6

Technique

Surgical Technique	7
------------------------------	---

Set Information

Set Contents	13
------------------------	----

The AO ASIF Principles of Internal Fixation

In 1958, the AO ASIF (Association for the Study of Internal Fixation) formulated four basic principles,¹ which have become the guidelines for internal fixation. They are:

- Anatomical reduction
- Stable internal fixation
- Preservation of blood supply
- Early, active pain-free mobilization

The fundamental aims of fracture treatment in the limbs and fusion of the spine are the same. A specific goal is returning as much function as possible to the injured neural elements.²

AO ASIF Principles as Applied to the Spine³

Anatomical Alignment

Restoration of normal spinal alignment to improve the biomechanics of the spine.

Stable Internal Fixation

Stabilization of the spinal segment to promote bony fusion.

Preservation of Blood Supply

Creation of an optimal environment for fusion.

Early, Pain-Free Mobilization

Minimization of damage to the spinal vasculature, dura, and neural elements, which may contribute to pain reduction and improved function for the patient.

1. M.E. Müller, M. Allgöwer, R. Schneider, and R. Willenegger: *AO Manual of Internal Fixation*, 3rd Edition. Berlin; Springer-Verlag, 1991.

2. Ibid.

3. M. Aebi, J.S. Thalgott, and J.K. Webb. *AO ASIF Principles in Spine Surgery*. Berlin; Springer-Verlag, 1998.

AO Principles of the Synex System

AO Spine Principle	Synex Technique Feature	Clinical Importance
Anatomical Alignment		
Restore vertebral body height	Expandable implants aid in the restoration and maintenance of vertebral body height and decompression of neural elements	Maintains decompression of neural elements and restores normal spinal alignment
Restore lordosis/kyphosis	Angled implant endplates are designed to allow restoration of the natural curvature of the spine	
Stable Internal Fixation		
Preserve endplates	Serrated, convex endplates with large contact surface area maximize implant/vertebral body interface	Minimizes implant subsidence and resists implant migration
Provide stability	Implants tested to withstand the axial compressive loads of the anterior spinal column Designed to be used with supplemental internal fixation	Stabilizes segment and promotes fusion



AO Spine Principle**Synex Technique Feature****Clinical Importance**

Preservation of Blood Supply

Provide optimum fusion bed

Peripheral bone graft placement is facilitated using the Synex technique



Creates an optimal environment for fusion

Early, Pain-Free Mobilization

Use atraumatic technique

The Synex technique eliminates the need for overdistraction of the graft site and minimizes impaction necessary for implant placement



Minimizes trauma to patient and may lead to pain reduction and improved function

Implant Features

Expansion mechanism

- Self-locking ratchet
- Each ratchet step equals 2.5 mm of distraction
- Rapid, controlled in situ expansion of the implant in the corpectomy site



Endplate design

- Large endplate contact surfaces designed to minimize subsidence into adjacent vertebral bodies
- Convex surfaces match vertebral body endplate anatomy
- Teeth and spikes designed to minimize implant migration
- Kyphotic and lordotic configurations available



Access for bone graft

- Large window for internal bone graft placement after expansion
- Endplate preserves space for peripheral bone graft placement

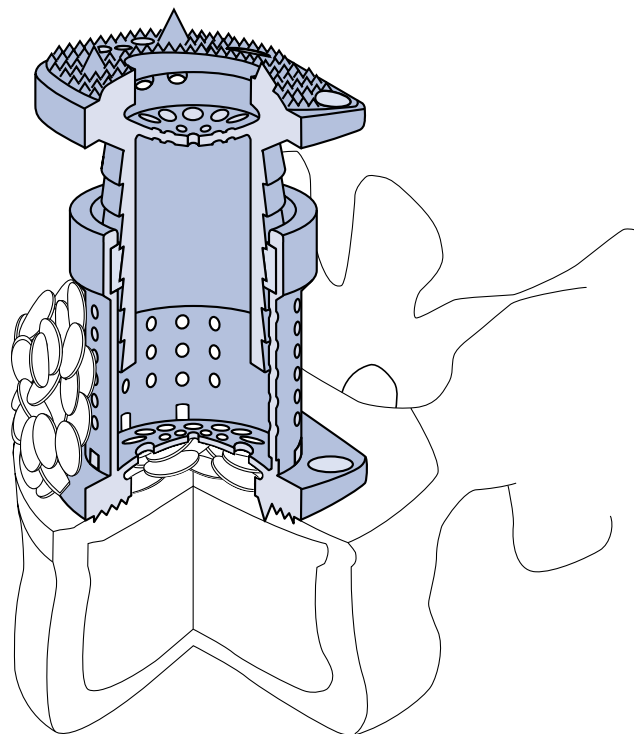

Implant Configurations

Green implants

The green Synex implants (small endplates) are used in the upper to midthoracic spine. They are available with 5° kyphotic endplates in a range of heights:

- 23–31 mm
- 28–40 mm
- 36–56 mm



Blue implants

The blue Synex implants (large endplates) are used in the lower thoracic and lumbar spine. They are available in six height ranges with four different angulations to meet the anatomical needs of the spine.



Parallel (0°) endplates are available in three different heights:

- 23–31 mm
- 26–36 mm
- 31–46 mm

Lordotic angulations are available in two height ranges:

- 33–48 mm, 10°
- 37–55 mm, 20°

A kyphotic-angled (-6°) implant is also available to address two-level defects of the lower thoracic spine:

- 45–73 mm, -6°

Note: Implants shown actual size.

Synex System Instruments

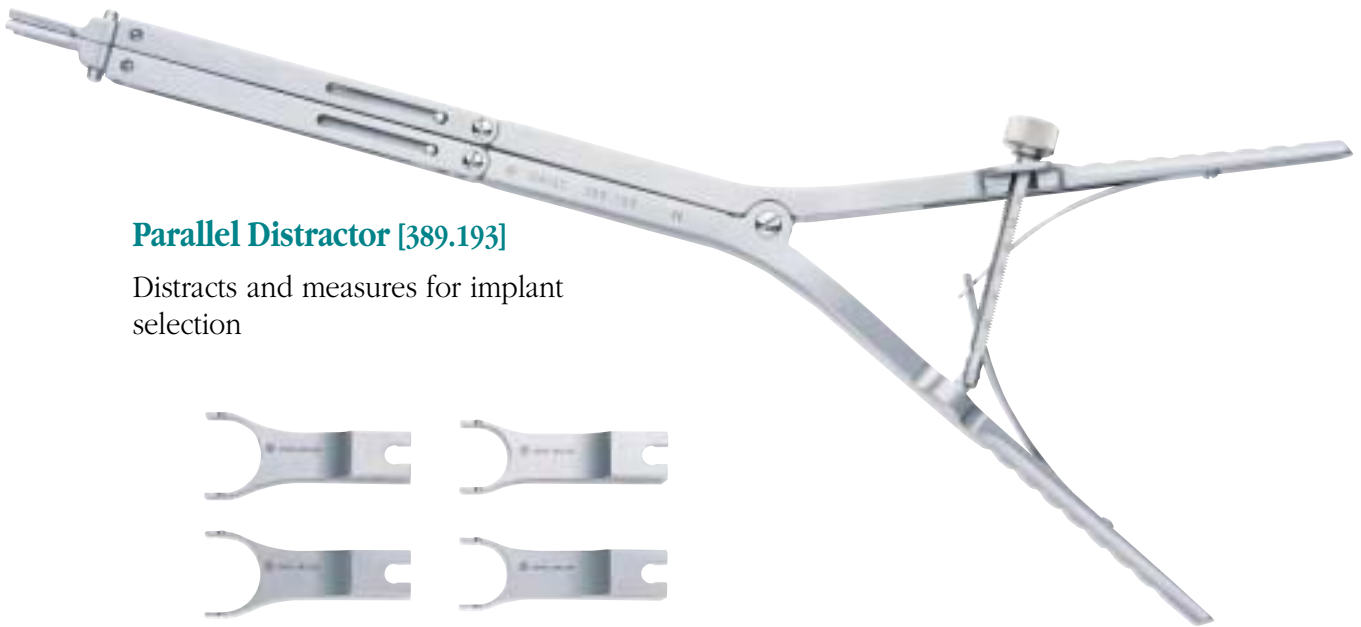

Parallel Distractor [389.193]

Distracts and measures for implant selection

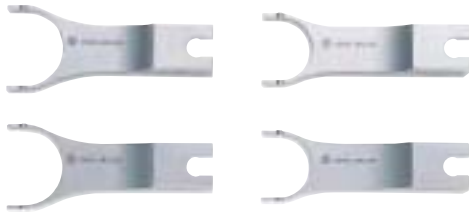

Large and Small Headpieces for use with Synex Parallel Distractor [389.205, 389.206]

Attach to Parallel Distractor to expand implant in situ

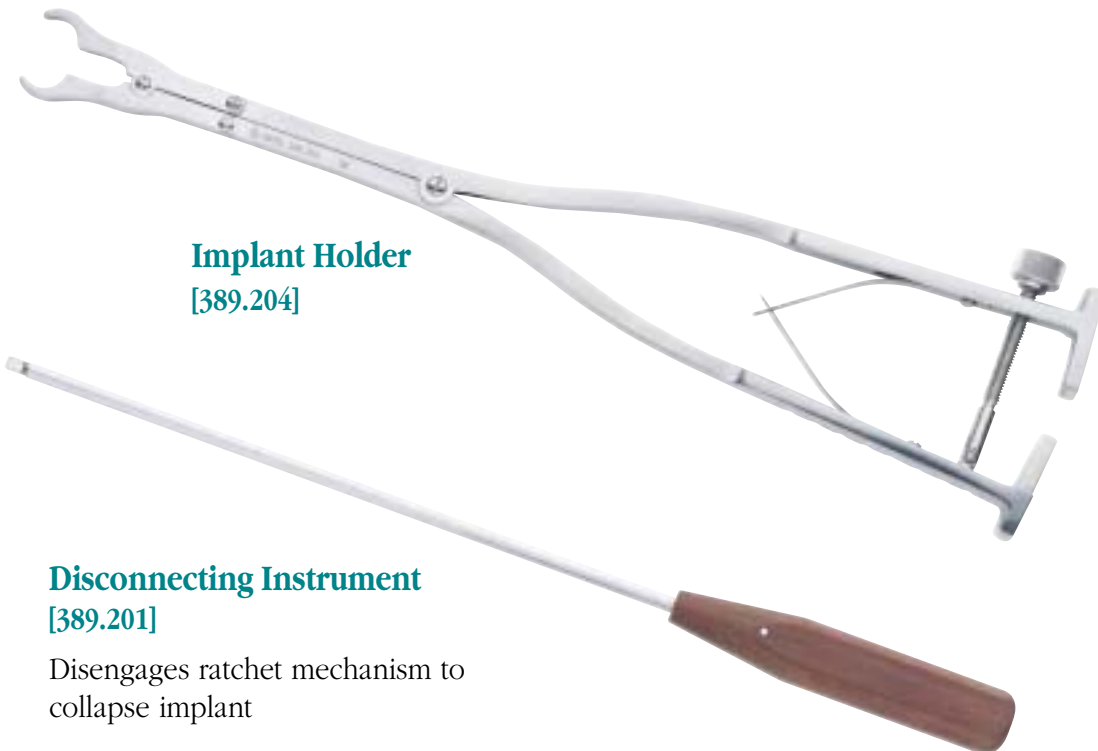

Implant Holder [389.204]

Disconnecting Instrument [389.201]

Disengages ratchet mechanism to collapse implant

Surgical Technique

1 Choose the appropriate approach

Use a lateral or anterolateral approach, depending on the spinal level involved.

2 Perform corpectomy

Perform a partial or complete corpectomy as required.

Note: Remove the superficial layers of the entire cartilaginous endplates and expose bleeding bone. Excessive removal of subchondral bone may weaken the vertebral endplate. If the entire endplate is removed, subsidence and a loss of segmental stability may result.

3 Determine implant size

Determine the height of the corpectomy site with the desired correction using the Parallel Distractor [389.193]. The scale on the handle of the Parallel Distractor indicates the height of the implant needed to fill the void.

Use the Preoperative Planner [8203] and the following tips to select an implant and simplify insertion:

- The height of the implant in its neutral position should be less than the undistracted corpectomy height.
- Subtract 4 mm from the value read on the distractor scale to account for the height of the three tallest spikes.
- The maximum expanded height of the implant should exceed the measured corpectomy height.

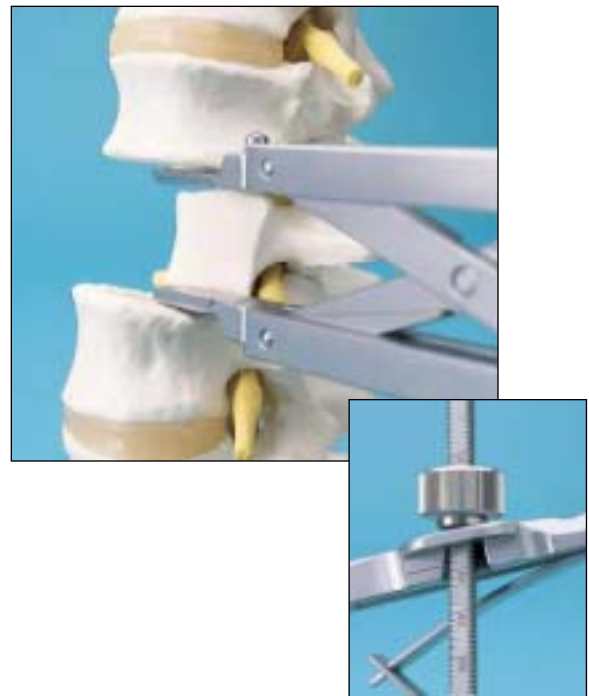

Surgical Technique (continued)

4 Pick up implant

Grasp the implant with the Implant Holder [389.204] close to the locking ring, with the implant release opening facing the fork of the Implant Holder.

Note: For the smallest implants [495.315 and 495.316] place the Implant Holder close to the lower implant endplate (see step 8 on page 10).



5 Fill with bone graft

Fill the bone cups in the implant endplates with bone graft before implantation.

The hollow body of the implant is filled after expansion.

Place bone graft in the contralateral side of the corpectomy (which cannot be reached after insertion of the Synex implant).



6 Insert implant

Guide and position the implant with the Implant Holder. Ensure that the release opening is facing the implant holder to allow repositioning if necessary.

Note: One implant should be implanted per level.

The optimal position for the implant is in the center of the vertebral endplate. Maintain space around the endplate of the implant to allow for peripheral bony fusion.



7 Attach headpieces to Parallel Distractor

Attach the appropriate headpieces onto the blades of the Parallel Distractor for implant expansion. The headpiece sizes correspond to the implant diameters. Use the headpieces labeled “B” [389.206] for blue Synex implants and headpieces labeled “G” [389.205] for green Synex implants.

Note: After use, press the buttons on the distractor blades to remove the headpieces.



Surgical Technique (continued)

8 Expand the implant

Expand the Synex implant in situ using the Parallel Distractor. If necessary, the Implant Holder may be used simultaneously to maintain implant position during distraction.

Expand the implant until the desired amount of spinal correction is achieved. Each step of the ratchet mechanism produces 2.5 mm of distraction. A stop will engage if the implant reaches its maximum height, preventing the implant from separating.

Note: If a taller implant is required, remove the implant as described below (“Implant Repositioning”) and replace it with a longer implant.



When expanding the shorter Synex implants, the Parallel Distractor may press against the Implant Holder instead of the implant endplate.

Implant Repositioning

If it is necessary to reposition the implant, use the Disconnecting Instrument [389.201] to collapse the expanded implant to its neutral position.

Introduce the Disconnecting Instrument into the slot between the two ends of the locking ring and turn it one-quarter (1/4) of a revolution. Remove the implant using the Implant Holder.

Note: Do not reuse Synex implants once they have been implanted or expanded.



9 Verify locking ring is closed

After expansion, check the closure of the locking ring. If there is a gap of approximately 1 mm (a), the implant height is secure. If the slot is larger (b), expand the implant slightly to engage the locking ring.

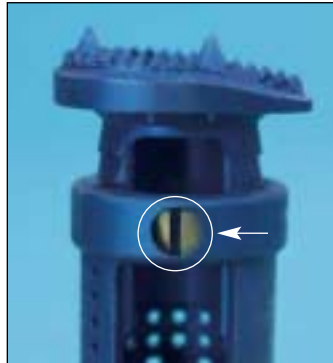

a. Locking ring is secure.



b. Locking ring is not secure.

10 Place bone graft

Radiographically verify the position of the implant in relation to the vertebral bodies in the frontal and sagittal planes intraoperatively.



Pack bone graft in and around the cage, especially the anterior zone of the corpectomy site.



Surgical Technique (continued)

11 Apply supplemental fixation

To ensure stability of the spine and maintain adequate compression on the Synex construct, the Synex system is indicated for use with supplemental anterior and/or posterior fixation. The following systems may be used: VentroFix, ATLP, and/or USS. Refer to the appropriate technique guides for information on the indications, descriptions, contraindications, precautions, warnings, and potential risks associated with these supplemental fixation implant systems.

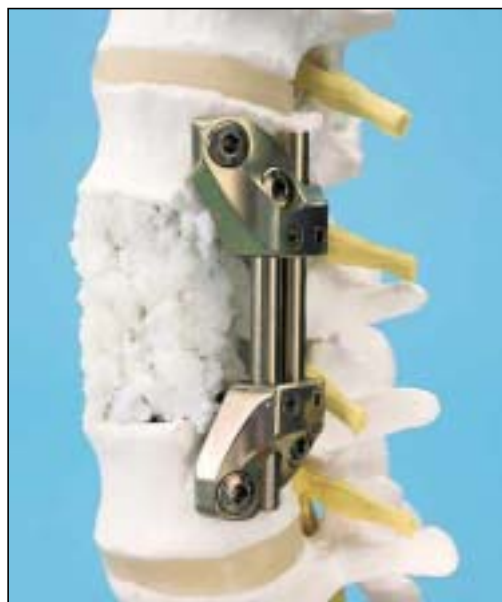

Synex™ System Instrument and Implant Set [145.305]

690.052 Synex™ System Instrument and Implant Set Graphic Case

Synex™ Implants

Small endplate (green)	
495.315	-5°, 23 mm–31 mm height
495.318	-5°, 28 mm–40 mm height
495.325	-5°, 36 mm–56 mm height
Large endplate (blue)	
495.316	0°, 23 mm–31 mm height
495.317	0°, 26 mm–36 mm height
495.319	0°, 31 mm–46 mm height
495.321	10°, 33 mm–48 mm height
495.323	20°, 37 mm–55 mm height
495.327	-6°, 45 mm–73 mm height

Instruments

389.193	Parallel Distractor
389.201	Disconnecting Instrument
389.204	Implant Holder
389.205	Small Headpiece for use with Synex™ Parallel Distractor, 2 ea.
389.206	Large Headpiece for use with Synex™ Parallel Distractor, 2 ea.
8203	Synex™ Preoperative Planner

SYNTHES Spine

1690 Russell Road
Paoli, PA 19301-1262
Telephone: (610) 647-9700
Fax: (610) 251-9056
To order: (800) 523-0322

SYNTHES (CANADA) LTD.

111 Brunel Road
Suite 110
Mississauga, Ontario L4Z 1X3
Telephone: (905) 568-1711
Fax: (905) 568-1662
To order: (800) 668-1119

